

## 120V N-Ch Power MOSFET

### Feature

- ◇ High Speed Power Smooth Switching
- ◇ Enhanced Body diode dv/dt capability
- ◇ Enhanced Avalanche Ruggedness
- ◇ 100% UIS Tested, 100% Rg Tested
- ◇ Lead Free

### Application

- ◇ Synchronous Rectification in SMPS
- ◇ Hard Switching and High Speed Circuit
- ◇ Power Tools
- ◇ UPS
- ◇ Motor Control

$V_{DS}$		120	V
$R_{DS(on),typ}$	TO-263	3.6	m $\Omega$
$R_{DS(on),typ}$	TO-220	3.9	m $\Omega$
$I_D$ (Silicon Limited)		167	A

TO-263



TO-220

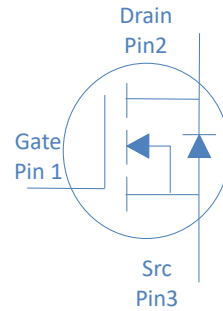

Part Number	Package	Marking
HGB047N12S	TO-263	GB047N12S
HGP047N12S	TO-220	GP047N12S

### Absolute Maximum Ratings at $T_j=25^\circ\text{C}$ (unless otherwise specified)

Parameter	Symbol	Conditions	Value	Unit
Continuous Drain Current (Silicon Limited)	$I_D$	$T_C=25^\circ\text{C}$	167	A
		$T_C=100^\circ\text{C}$	118	
Drain to Source Voltage	$V_{DS}$	-	120	V
Gate to Source Voltage	$V_{GS}$	-	$\pm 20$	V
Pulsed Drain Current	$I_{DM}$	-	480	A
Avalanche Energy, Single Pulse	$E_{AS}$	$L=0.3\text{mH}, T_C=25^\circ\text{C}$	540	mJ
Power Dissipation	$P_D$	$T_C=25^\circ\text{C}$	300	W
Operating and Storage Temperature	$T_J, T_{stg}$	-	-55 to 175	$^\circ\text{C}$

### Absolute Maximum Ratings

Parameter	Symbol	Max	Unit
Thermal Resistance Junction-Case	$R_{\theta JC}$	0.5	$^\circ\text{C/W}$
Thermal Resistance Junction-Ambient	$R_{\theta JA}$	60	$^\circ\text{C/W}$

**Electrical Characteristics at  $T_J=25^{\circ}\text{C}$  (unless otherwise specified)**
**Static Characteristics**

Parameter	Symbol	Conditions	Value			Unit	
			min	typ	max		
Drain to Source Breakdown Voltage	$V_{(BR)DSS}$	$V_{GS}=0V, I_D=250\mu A$	120	-	-	V	
Gate Threshold Voltage	$V_{GS(th)}$	$V_{GS}=V_{DS}, I_D=250\mu A$	2	3	4		
Zero Gate Voltage Drain Current	$I_{DSS}$	$V_{GS}=0V, V_{DS}=120V, T_J=25^{\circ}\text{C}$	-	-	1	$\mu A$	
		$V_{GS}=0V, V_{DS}=120V, T_J=100^{\circ}\text{C}$	-	-	100		
Gate to Source Leakage Current	$I_{GSS}$	$V_{GS}=\pm 20V, V_{DS}=0V$	-	-	$\pm 100$	nA	
Drain to Source on Resistance	$R_{DS(on)}$	$V_{GS}=10V, I_D=20A$	TO-263	-	3.6	4.4	$m\Omega$
			TO-220	-	3.9	4.7	
Transconductance	$g_{fs}$	$V_{DS}=5V, I_D=20A$	-	80	-	S	
Gate Resistance	$R_G$	$V_{GS}=0V, V_{DS}$ Open, $f=1\text{MHz}$	-	2.7	-	$\Omega$	

**Dynamic Characteristics**

Input Capacitance	$C_{iss}$	$V_{GS}=0V, V_{DS}=60V, f=1\text{MHz}$	-	5360	-	pF
Output Capacitance	$C_{oss}$		-	626	-	
Reverse Transfer Capacitance	$C_{rss}$		-	13	-	
Total Gate Charge	$Q_g$	$V_{DD}=60V, I_D=20A, V_{GS}=10V$	-	63	-	nC
Gate to Source Charge	$Q_{gs}$		-	28	-	
Gate to Drain (Miller) Charge	$Q_{gd}$		-	7.5	-	
Turn on Delay Time	$t_{d(on)}$	$V_{DD}=60V, I_D=20A, V_{GS}=10V, R_G=10\Omega,$	-	22	-	ns
Rise time	$t_r$		-	16	-	
Turn off Delay Time	$t_{d(off)}$		-	31	-	
Fall Time	$t_f$		-	9.6	-	

**Reverse Diode Characteristics**

Diode Forward Voltage	$V_{SD}$	$V_{GS}=0V, I_F=20A$	-	0.9	1.2	V
Reverse Recovery Time	$t_{rr}$	$V_R=60V, I_F=20A, di_F/dt=500A/\mu s$	-	52	-	ns
Reverse Recovery Charge	$Q_{rr}$		-	312	-	nC

Fig 1. Typical Output Characteristics

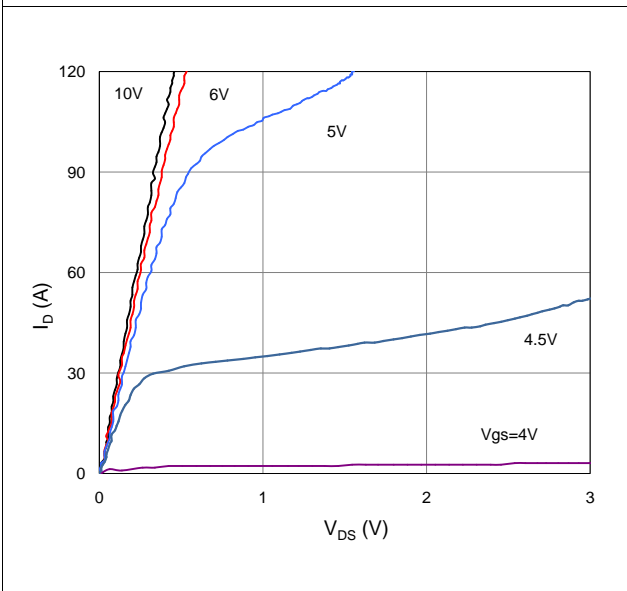

Figure 2. On-Resistance vs. Gate-Source Voltage

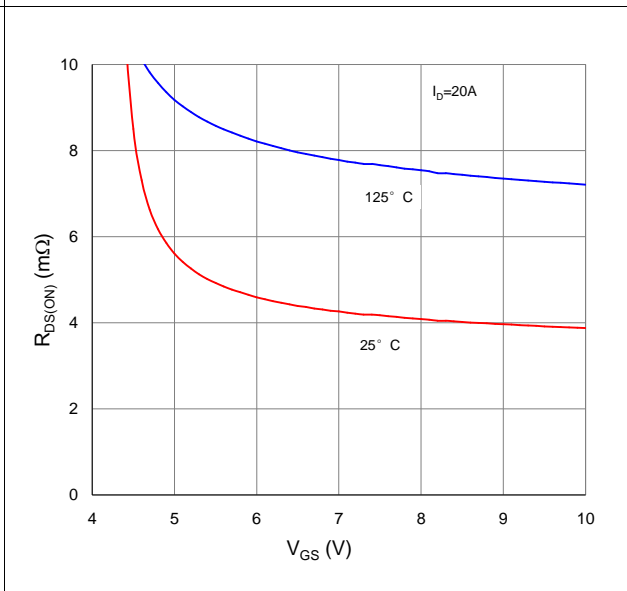

Figure 3. On-Resistance vs. Drain Current and Gate Voltage

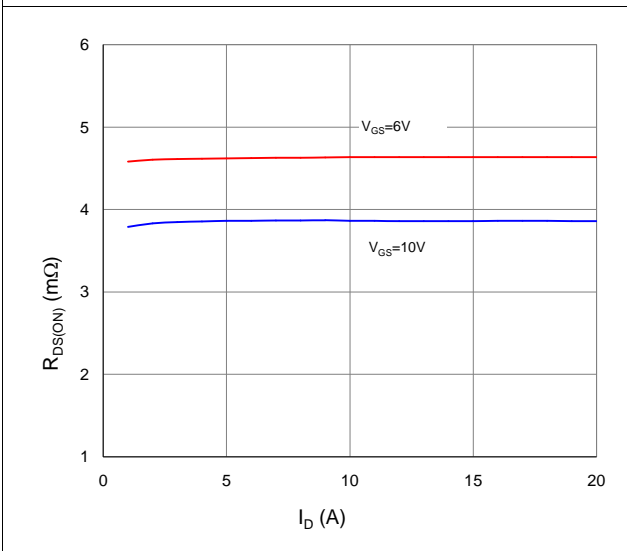

Figure 4. Normalized On-Resistance vs. Junction Temperature

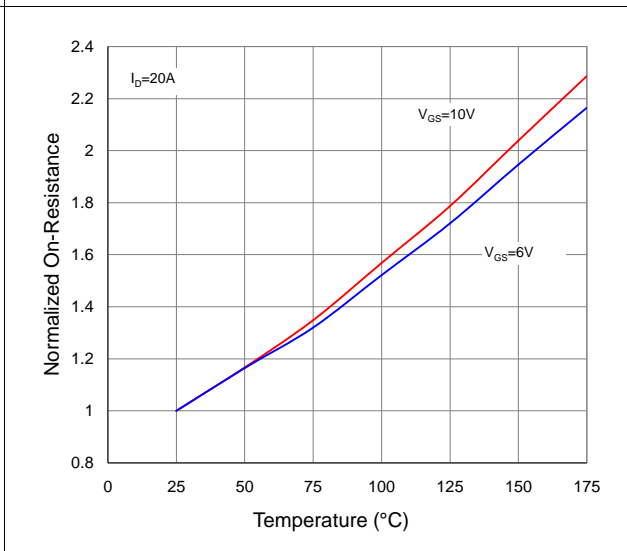

Figure 5. Typical Transfer Characteristics

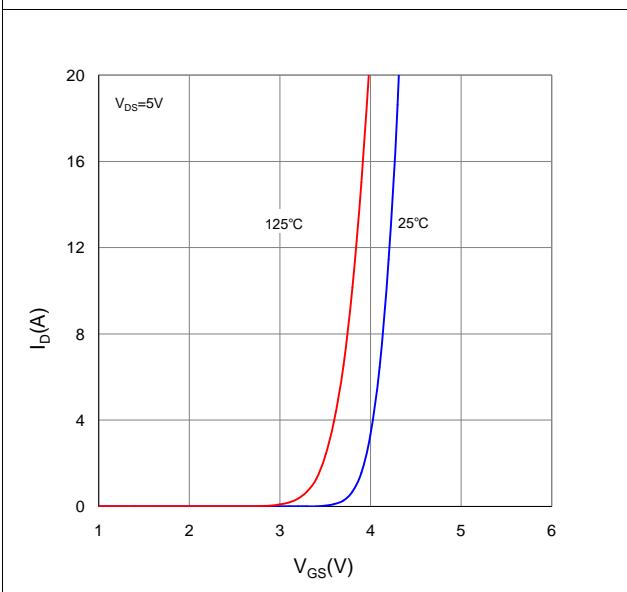

Figure 6. Typical Source-Drain Diode Forward Voltage

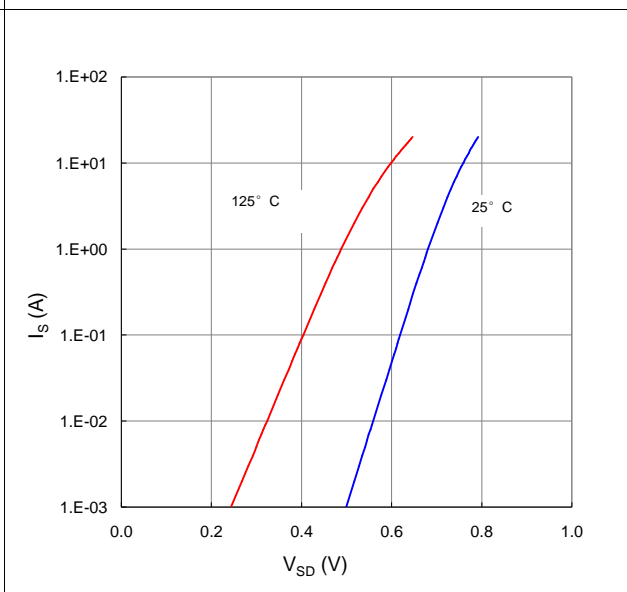

Figure 7. Typical Gate-Charge vs. Gate-to-Source Voltage

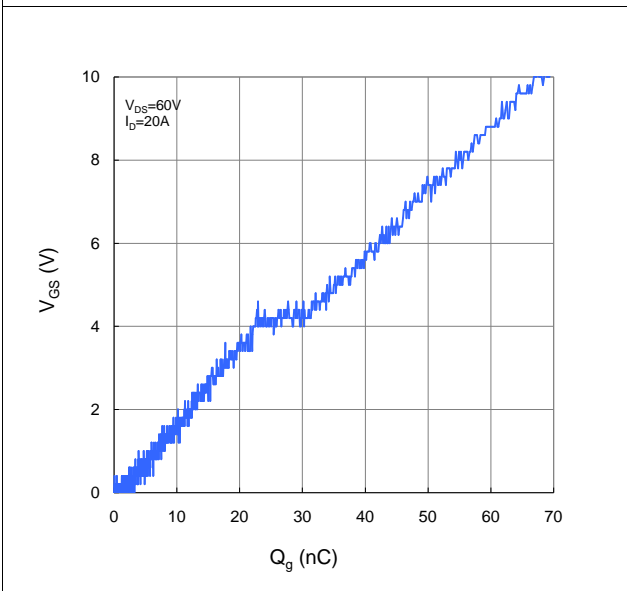

Figure 8. Typical Capacitance vs. Drain-to-Source Voltage

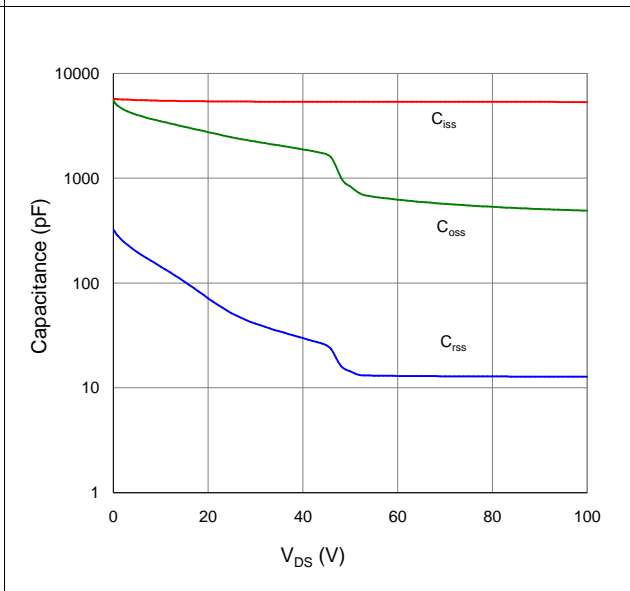

Figure 9. Maximum Safe Operating Area

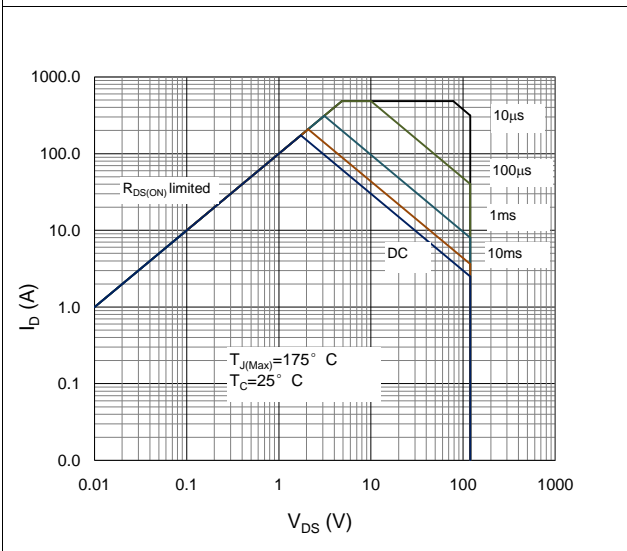

Figure 10. Maximum Drain Current vs. Case Temperature

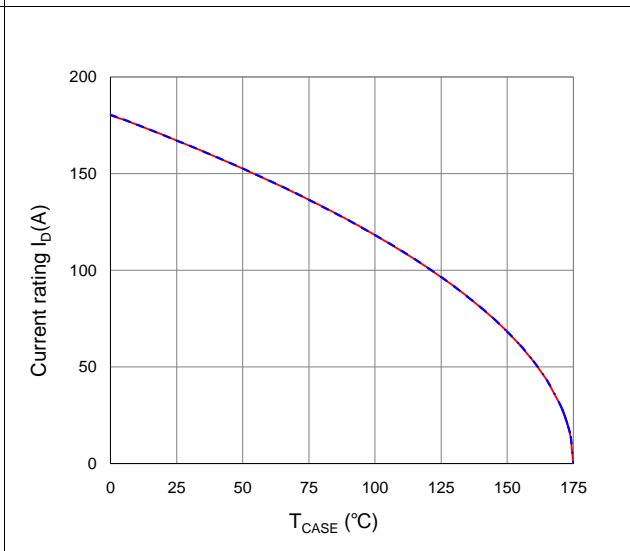
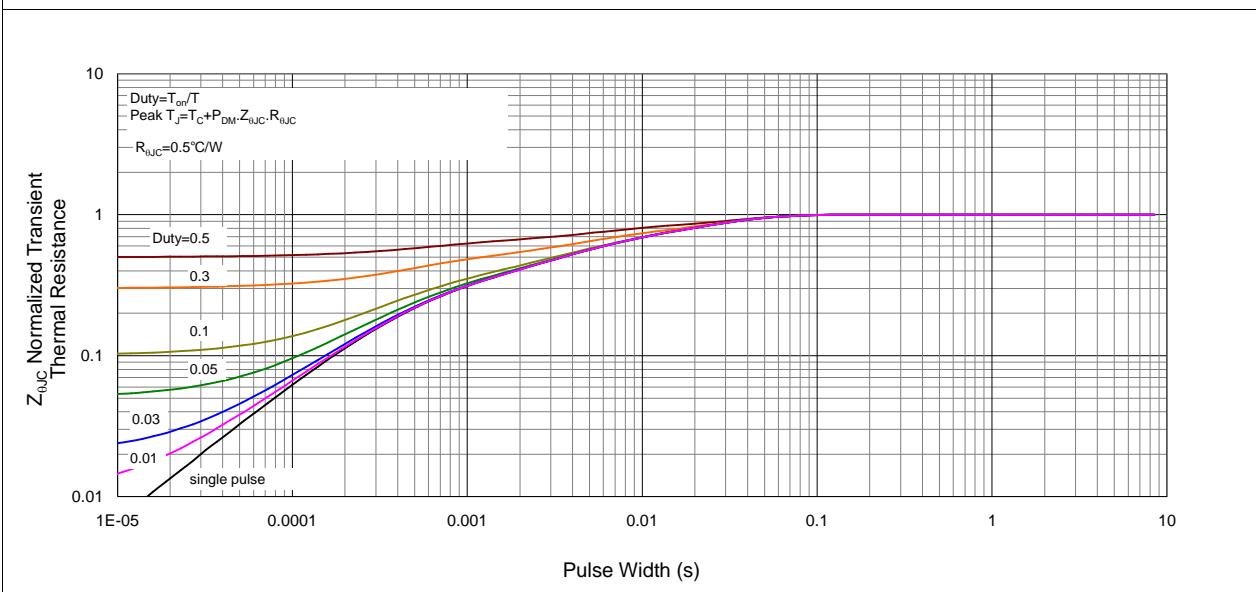
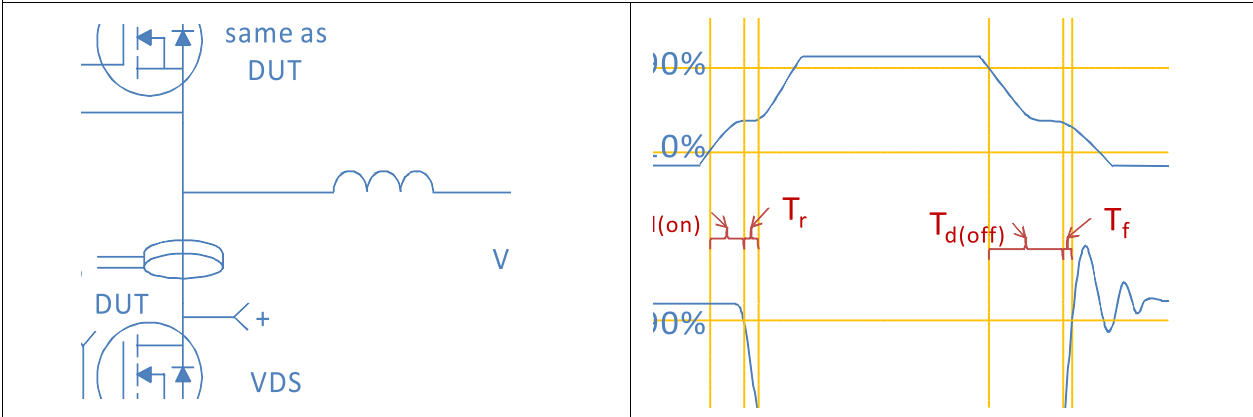

Figure 11. Normalized Maximum Transient Thermal Impedance, Junction-to-Case



Inductive switching Test



Gate Charge Test

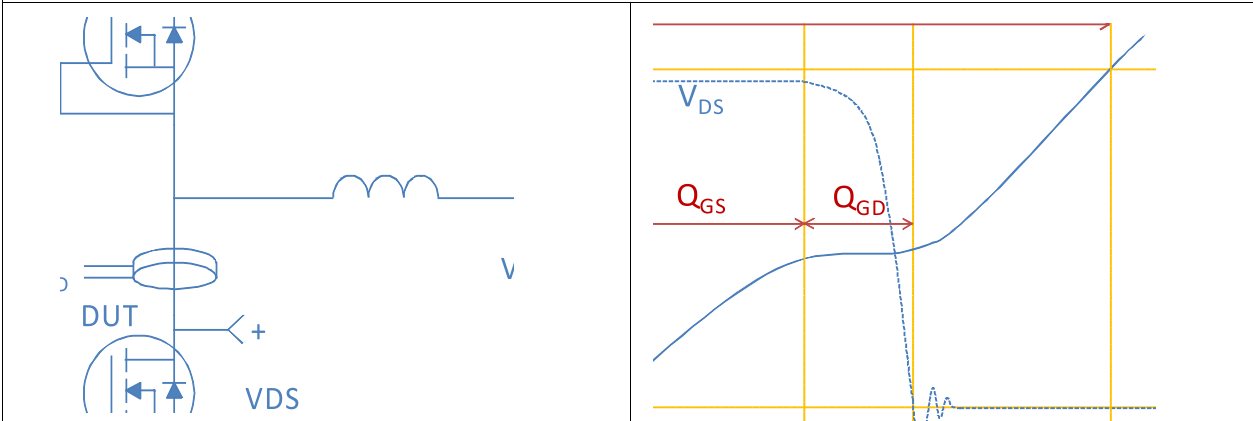

Uclamped Inductive Switching (UIS) Test

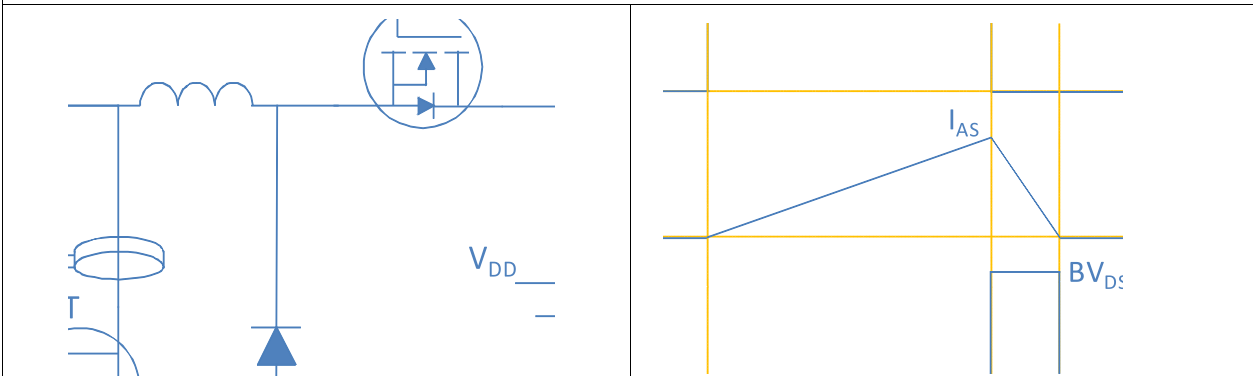

Diode Recovery Test

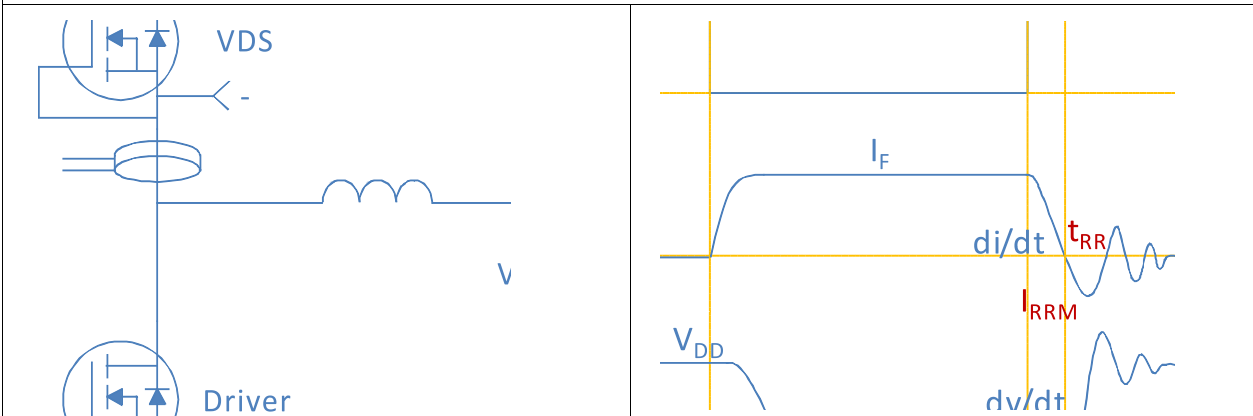

TO-220, 3 leads

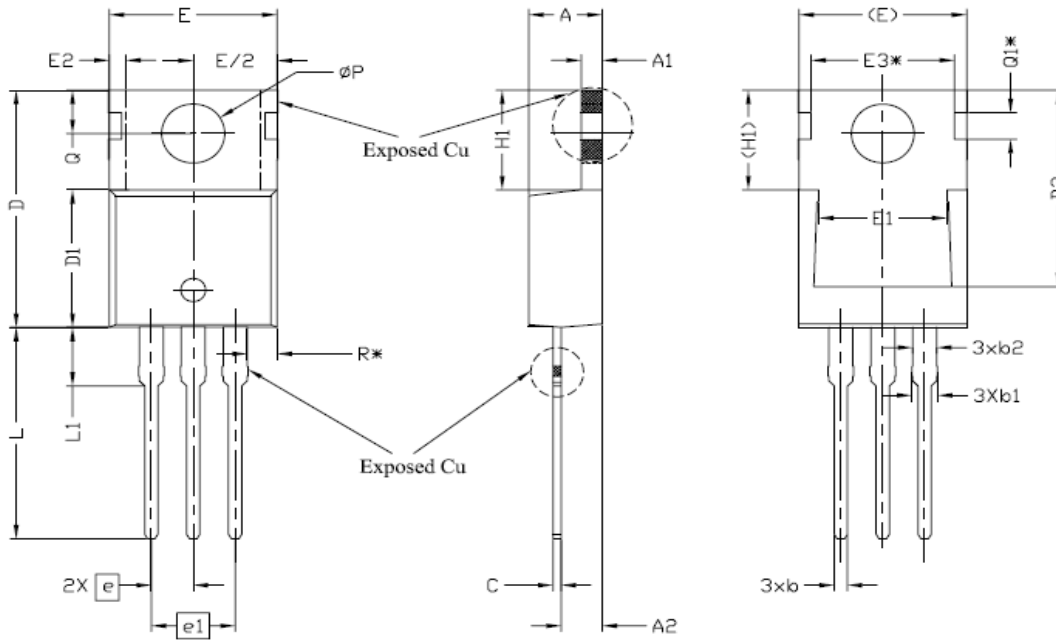

SYMBOL	DIMENSIONS			NOTES
	MIN.	NOM.	MAX.	
A	4,24	4,44	4,64	
A1	1,15	1,27	1,40	
A2	2,30	2,48	2,70	
b	0,70	0,80	0,90	
b1	1,20	1,55	1,75	
b2	1,20	1,45	1,70	
c	0,40	0,50	0,60	
D	14,70	15,37	16,00	4
D1	8,82	8,92	9,02	
D2	12,63	12,73	12,83	5
E	9,96	10,16	10,36	4,5
E1	6,86	7,77	8,89	5
E2	-	-	0,76	6
E3*	8,70REF.			
e	2,54BSC			
e1	5,08BSC			
H1	6,30	6,45	6,60	5,6
L	13,47	13,72	13,97	
L1	3,60	3,80	4,00	
$\phi P$	3,75	3,84	3,93	
Q	2,60	2,80	3,00	
Q1*	1,73REF.			
R*	1,82REF.			

TO-263, 3 leads

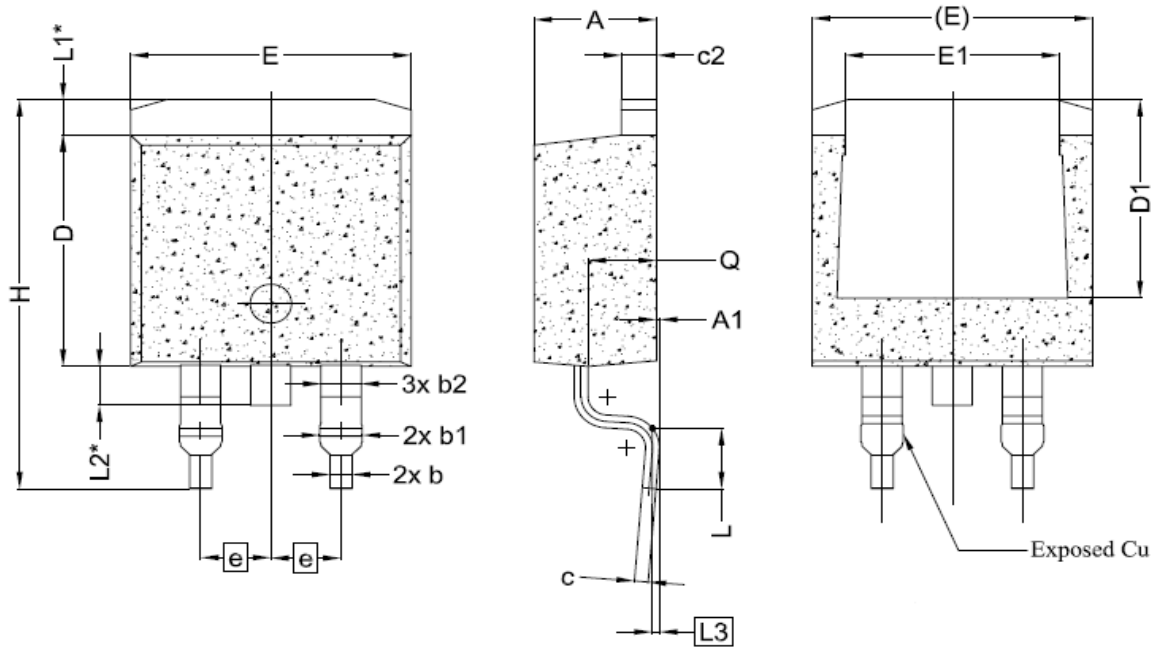

SYMBOL	DIMENSIONS		
	MIN.	NOM.	MAX.
A	4.24	4.44	4.64
A1	0.00	0.10	0.25
b	0.70	0.80	0.90
b1	1.20	1.55	1.75
b2	1.20	1.45	1.70
c	0.40	0.50	0.60
c2	1.15	1.27	1.40
D	8.82	8.92	9.02
D1	6.86	7.65	—
E	9.96	10.16	10.36
E1	6.89	7.77	7.89
e	2.54 BSC		
H	14.61	15.00	15.88
L	1.78	2.32	2.79
L1	1.36 REF.		
L2	1.50 REF.		
L3	0.25 BSC		
Q	2.30	2.48	2.70